

8

7

6

5

4

3

2

1

F

E

D

C

B

A

F

E

D

C

B

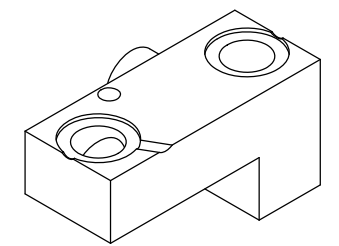
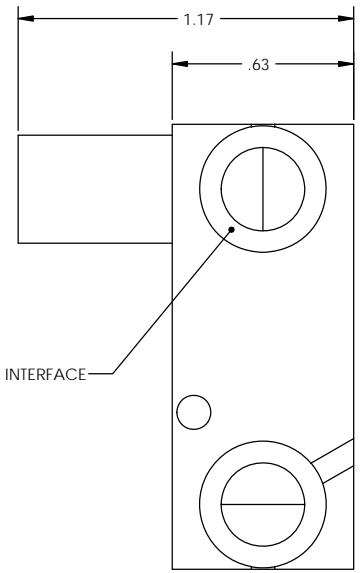

A

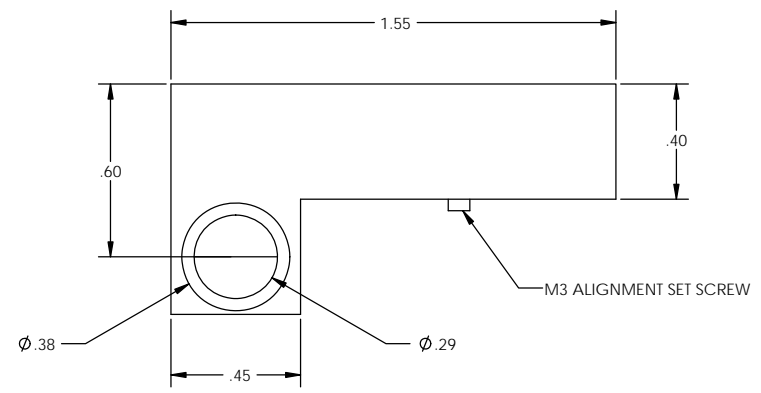
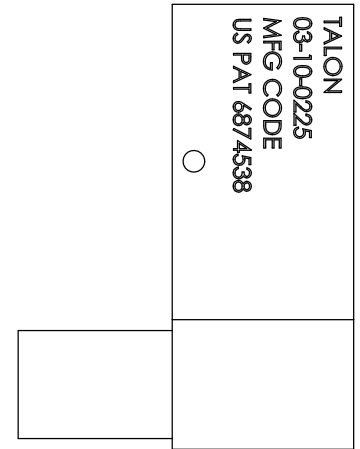
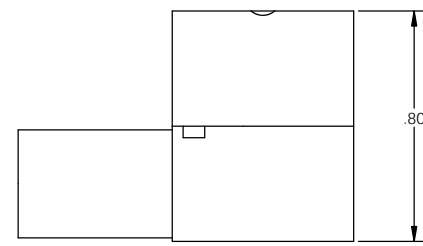

2X 1.5" HF C-SEAL INTERFACE



- NOTES:
1. DRAWINGS FOR SPECIFICATION PURPOSES AND ARE FOR REFERENCE ONLY.
 2. ALL VERSIONS OF THE DRAWING ARE SUPERSEDED BY THIS RELEASE AND SUBJECT TO CHANGE WITHOUT NOTIFICATION.
 3. MATERIAL: 316L SST, SEMI F20.
 4. INTERNAL FINISHES: MACHINED AND ELECTROPOLISHED TO 5 Ra MAX.

EFFECTIVE DATE: 2/6/2017		 INNOVATION WITH PRECISION 1003 INDUSTRIAL DRIVE SAUK RAPIDS, MN 56379 VOICE: 320-251-0390 FAX: 320-251-5810
INTERPRET DRAWING PER: ASME Y14.5 - 2009		
THIRD ANGLE PROJECTION 		
PROPRIETARY AND CONFIDENTIAL THE INFORMATION CONTAINED IN THIS DRAWING IS THE SOLE PROPERTY OF TALON INNOVATIONS, INC. ANY REPRODUCTION IN PART OR AS A WHOLE WITHOUT THE WRITTEN PERMISSION OF TALON INNOVATIONS, INC. IS PROHIBITED.		
DESCRIPTION: TMS 1.5" HF C-SEAL INSERT, BRANCH MANIFOLD LEFT		PART NUMBER: 03-10-0225
SIZE: C	SCALE: 3:1	SHEET 1 OF 1
DO NOT SCALE DRAWING		

8

7

6

5

4

3

2

1